

R6600-240

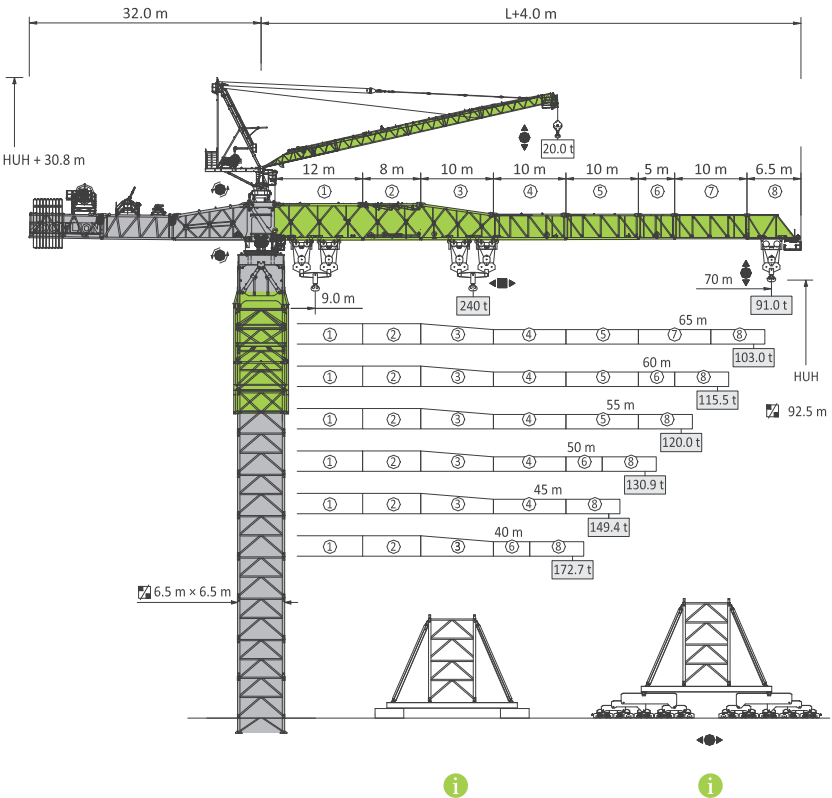

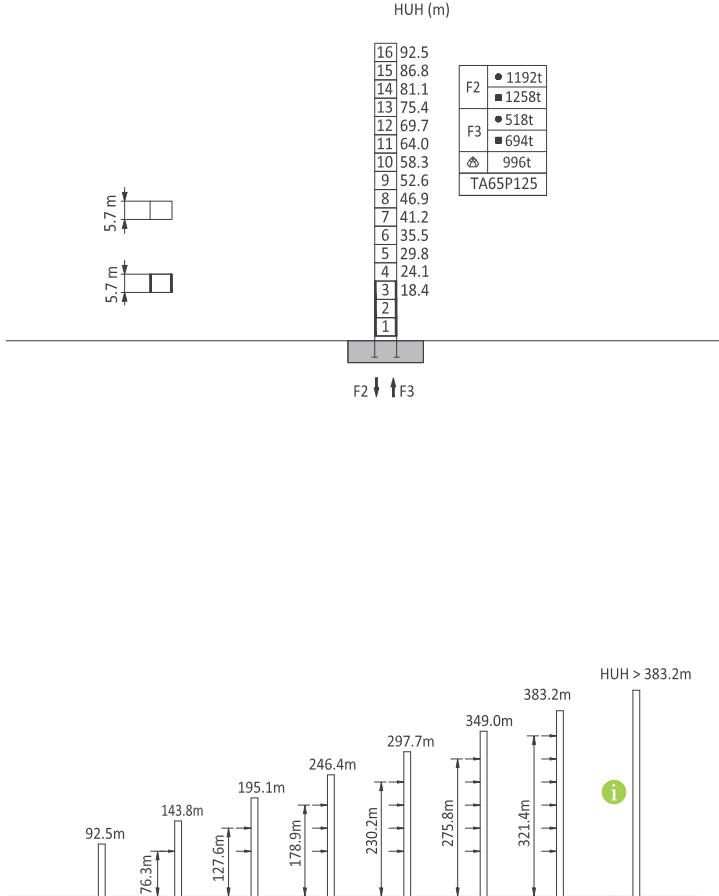







塔身—反力&附着 / Mast – Reactions & Anchorages / Mast – Fundament Ecklasten & Verankerungen

6.5m – ZC R6600-240



传动机构 / Mechanisms / Antriebe

380 V (± 10 %) 50 Hz									kW			
	2 x H200FC300-1600D	t	120	60	20	120	60	20	2 x 200	2 x 1600 m 		
		m/min	8	16	32	16	32	64				
												
		t	240	120	40							
		m/min	8	16	32							
	S185CA-350.275CD20/13B x3 S185CN-350.275CD20/13B x1	r/min	0 - 0.6						4 x 18.5			
	T450FC70	m/min	0 - 44						45			
			519 kW									



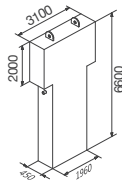
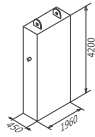





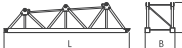

Counter-jib ballast / Gegenauslegerballast / 平衡重

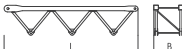

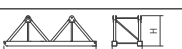

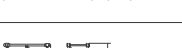

高度 m	18.0 t	10.0t	重量 (t)	PHZ18000	PHZ10000
70.0	8	1	154.0	 <p>(mm)</p>	 <p>(mm)</p>
65.0	8	0	144.0		
60.0	8	0	144.0		
55.0	7	1	136.0		
50.0	7	0	126.0		
45.0	6	1	118.0		
40.0	5	1	100.0		

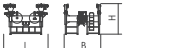
Central ballast / Zentralballast / 压重







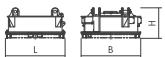
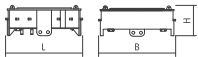
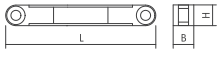
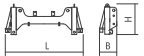

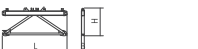

运输单元 / Dimensions and weight / Abmessungen und Gewicht

上装 / Slewing crane part / Drehender Kranteil		L (m)	B (m)	H (m)	kg (±5%)
平衡臂 Counter-jib Gegenausleger		10.80	2.80	3.60	12700
		10.10	2.70	2.50	10900
		10.60	3.70	2.80	21800
		10.30	2.70	3.60	17000
起重臂节 Jib section Auslegersegment	 ①	12.68	2.78	2.82	12500
	 ①	12.18	3.20	2.68	14300
	 ②	8.48	2.71	2.82	8600
	 ②	8.17	2.70	2.64	9100
	 ③	10.60	2.71	2.9	7600
	 ③	10.18	2.70	2.48	8700
	 ④	10.50	2.70	3.70	14800
	 ⑤	10.50	2.70	3.60	11300
	 ⑦	10.40	2.70	3.50	6800
	 ⑥	5.50	2.70	3.60	5200
载重小车 Trolley Laufkatze	 ⑧	7.50	2.80	5.10	4990
		3.90	3.30	2.70	2×5300

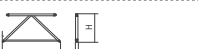
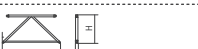
上装 / Slewing crane part / Drehender Kranteil		L (m)	B (m)	H (m)	kg (±5%)
吊钩 Pulley block Hubflasche		4.82	0.80	3.19	4920
		2.34	0.48	2.29	2×2990
司机室 Cabin Kabine		2.60	1.80	2.40	1500
起升机构 Hoisting mechanism Hubwerk	 H200FC300-1600D	5.40	3.20	4.00	38100
变幅机构 Trolleying mechanism Katzfahrwerk	 T450FC70	3.40	2.05	1.50	5700
塔头 Tower head Turmspitze		4.50	3.00	6.30	38200
上支座总成 Upper support Drehrahmenoberteil	 SR6600	4.80	4.90	2.50	42600
下支座总成 Slewing support Drehrahmenunterteil	 S65P125	4.90	4.90	2.40	45600
	 S65P125	4.80	0.70	0.70	8×2400
	 S65P125	7.80	1.60	2.70	2×10000

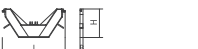
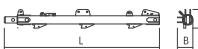
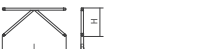
运输单元 / Dimensions and weight / Abmessungen und Gewicht

塔身 / Crane tower / Kranturm		L (m)	B (m)	H (m)	kg (±5%)	
引进系统 Mounting beam Einführungsträger		6.5 m-M65P50	14.90	4.20	1.50	8300
爬升架 Climbing tower section Kletterturmstück		6.5 m-TC65P120G	15.59	1.36	1.41	4×4760
			6.97	0.26	3.70	2×2500
			6.97	0.33	3.90	2×4720
			6.97	0.26	3.73	2×1970
			6.97	0.26	3.66	1×2082
			6.97	0.26	3.94	1×2040
			6.97	0.26	3.73	3×1970
	顶升机构 Climbing mechanism Kletterwerk			6.5 m-J65P120	6.12	0.40
标准节 Tower section Turmstück		6.5 m-X65G3035	6.30	1.30	0.80	4×2730
		6.5 m-X65G3035Rb	6.30	1.30	0.80	4×3150
支腿 Fixing angles Verankerungsfuss		TA65P125	3.12	0.83	0.83	4×1880